

Dibujo Técnico II 2ª evaluación

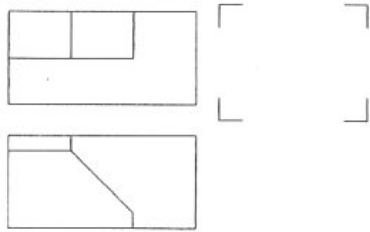

1 Halla la vista que falta y dibuja a escala 3:1

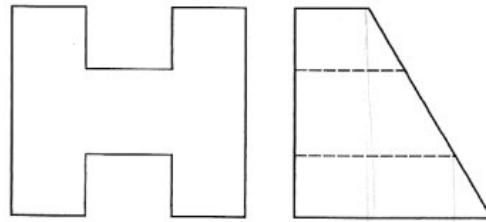

2 dibuja la figura en axonometría o caballera

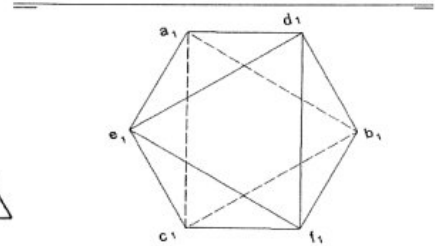

3 Alzado del octaedro

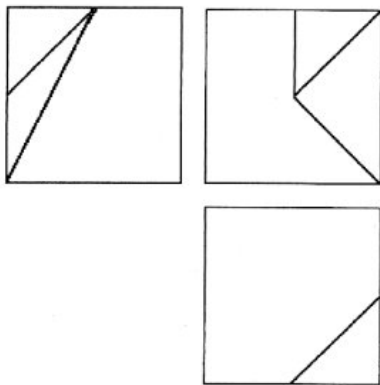

4 Dibuja en caballera ángulo:225, coeficiente 4/5

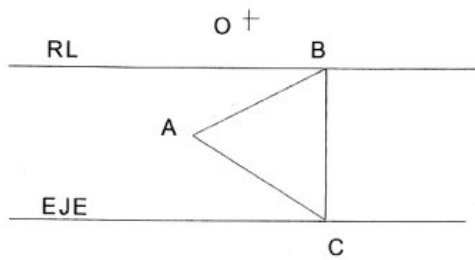

5. Homólogo del triángulo ABC

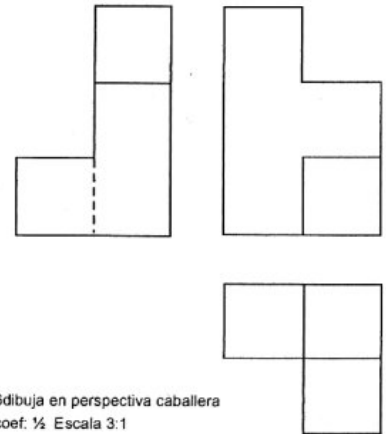

6dibuja en perspectiva caballera coef: 1/2 Escala 3:1

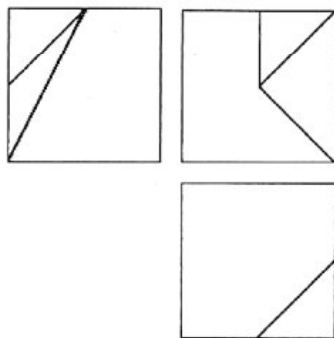

7 Dibuja en caballera o axonometría

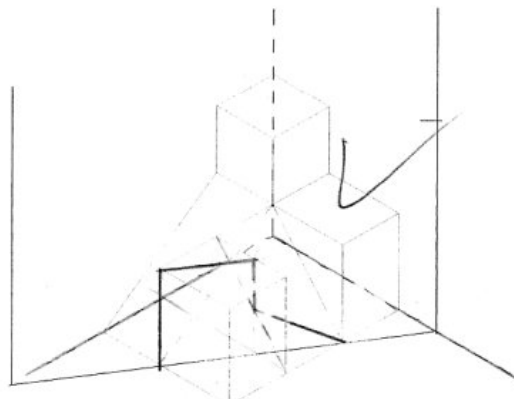

8 Dibuja el corte del plano sobre la figura

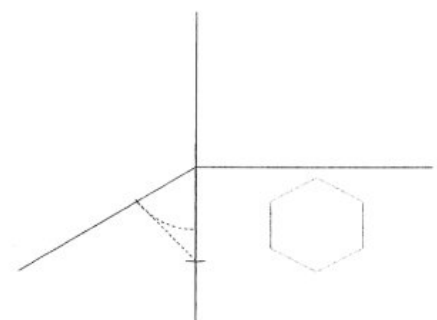

9 Dibuja un prisma de base exagonal (altura=50 mm)

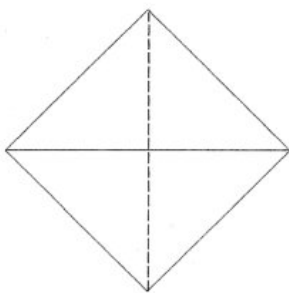

10 Halla el alzado de tetraedro

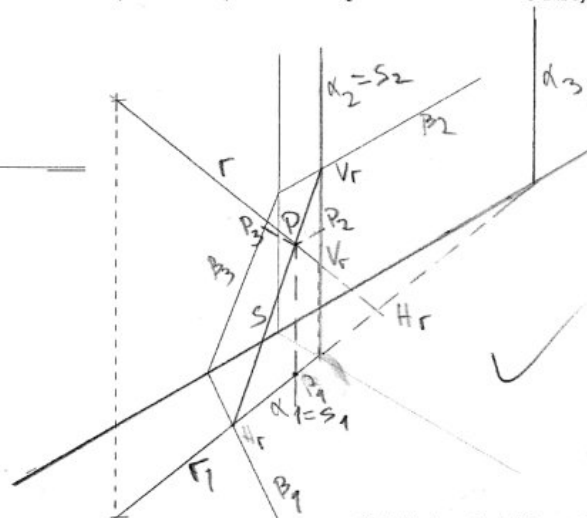

11 Halla el punto de intersección de R con el plano A

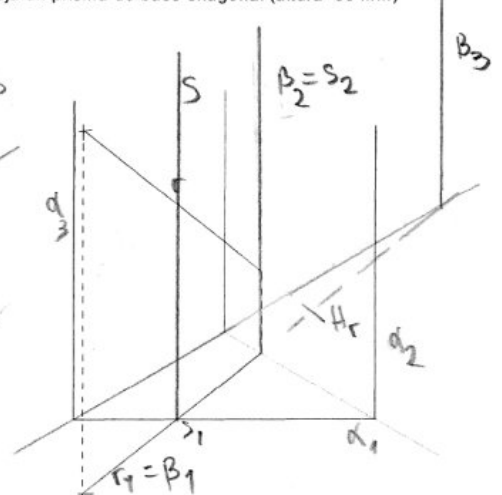

2

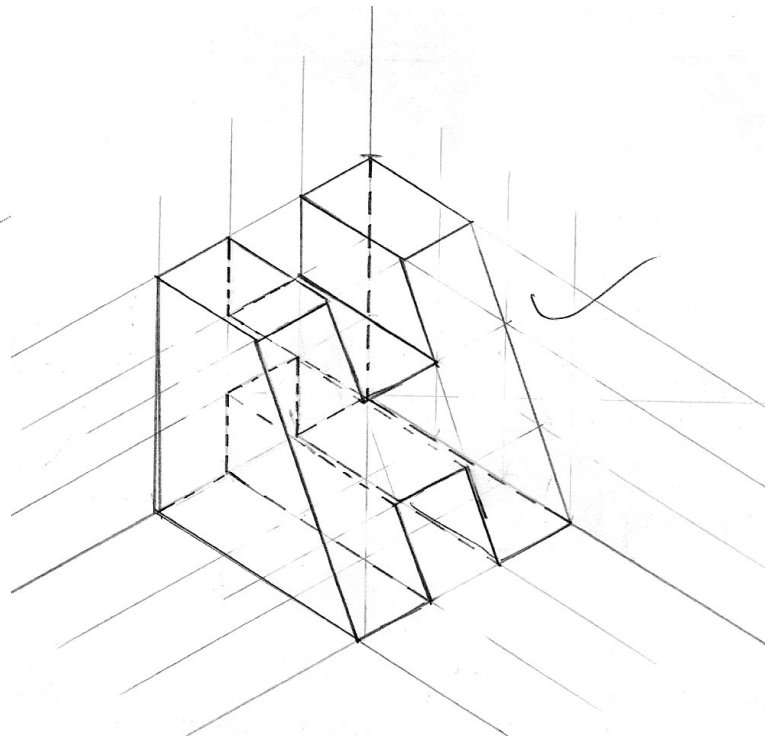
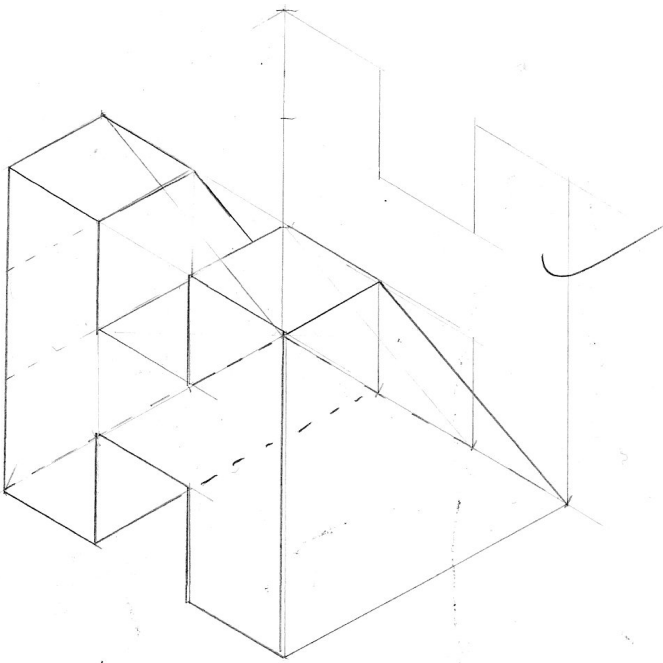

5

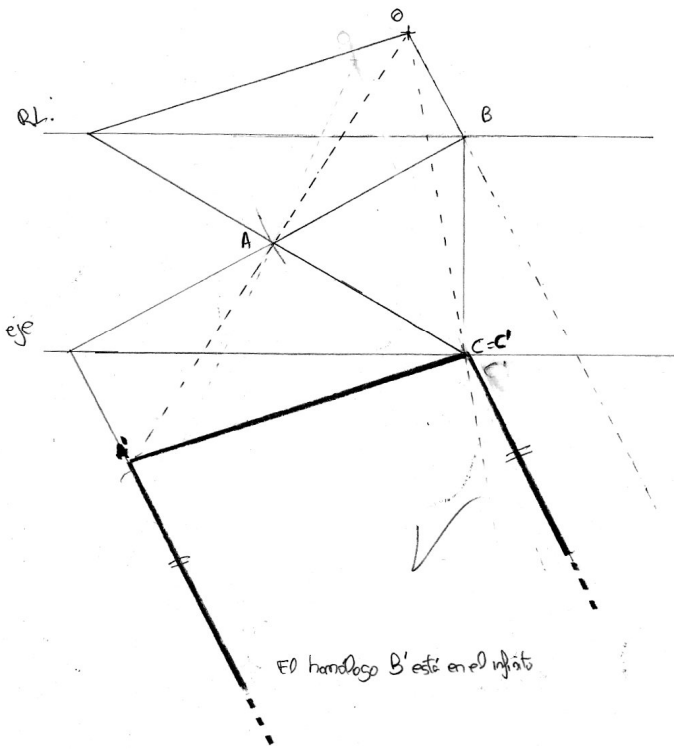

7

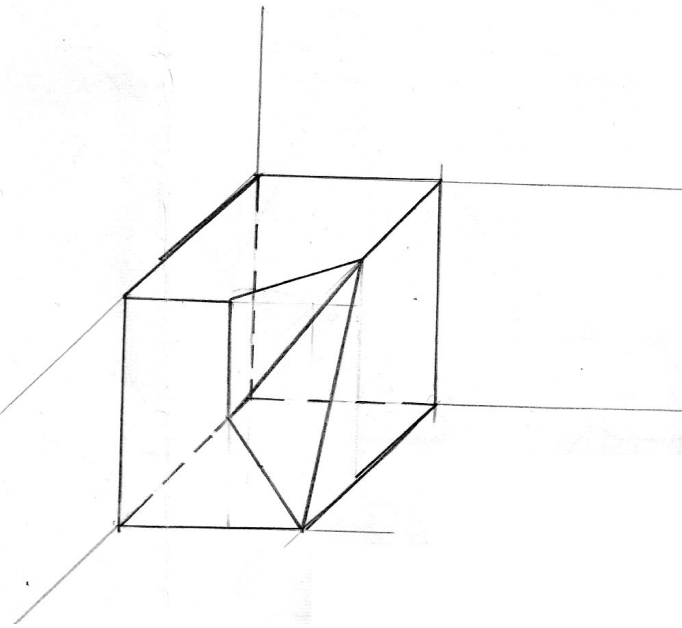

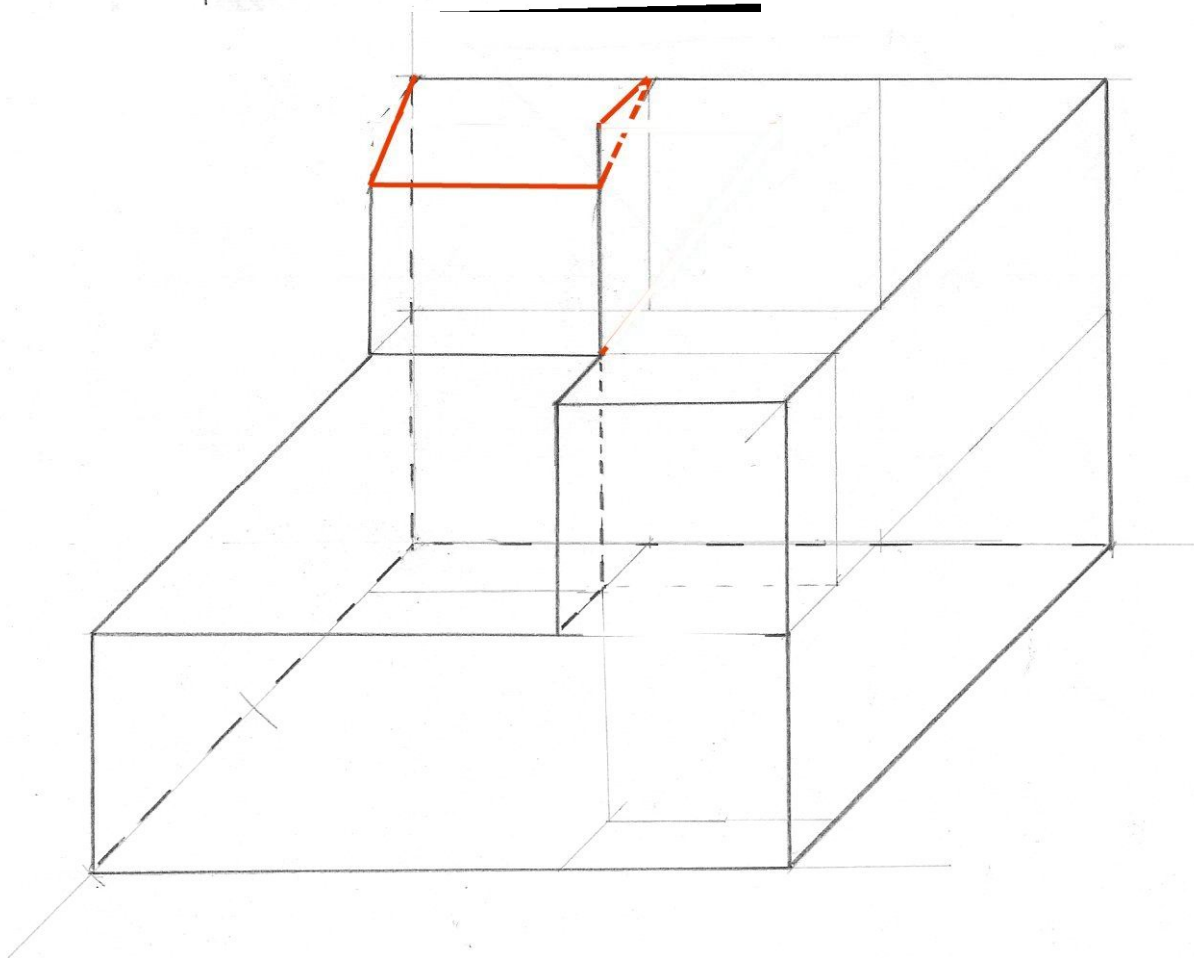
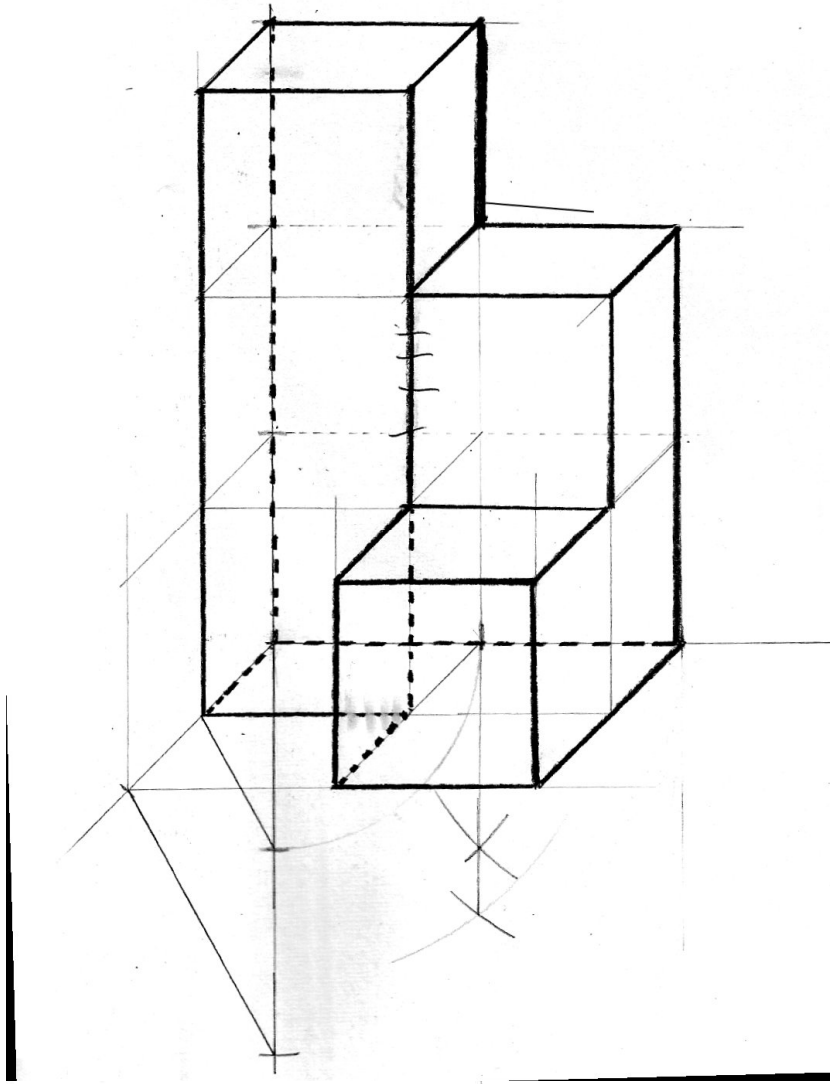

7

$\delta y \parallel z$

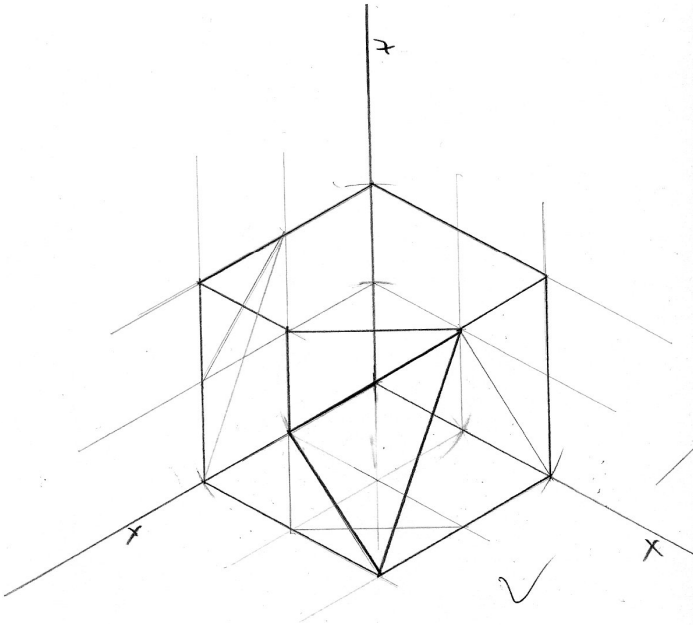

9

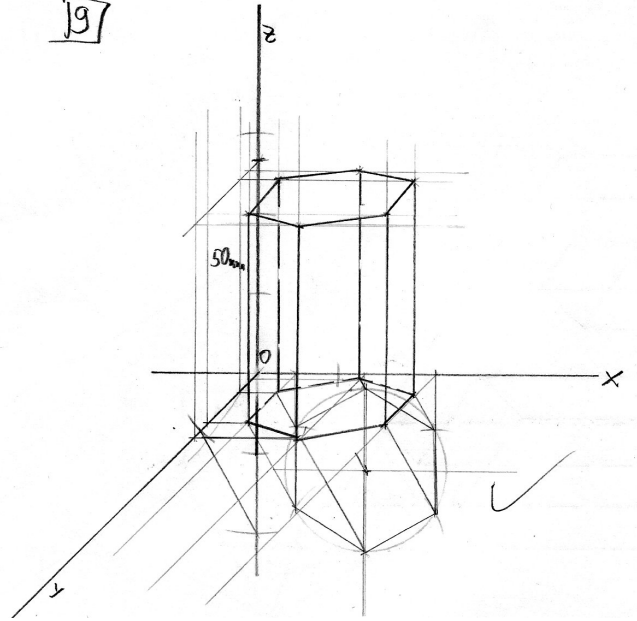

10

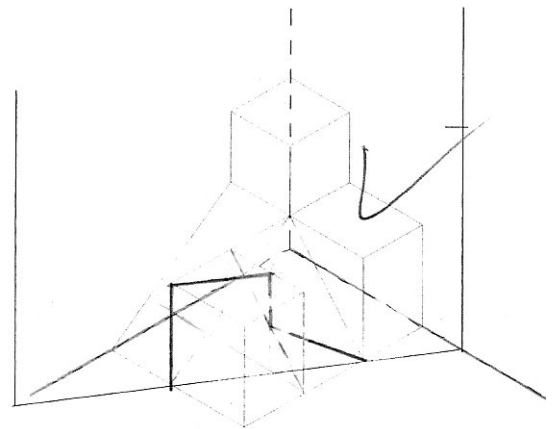
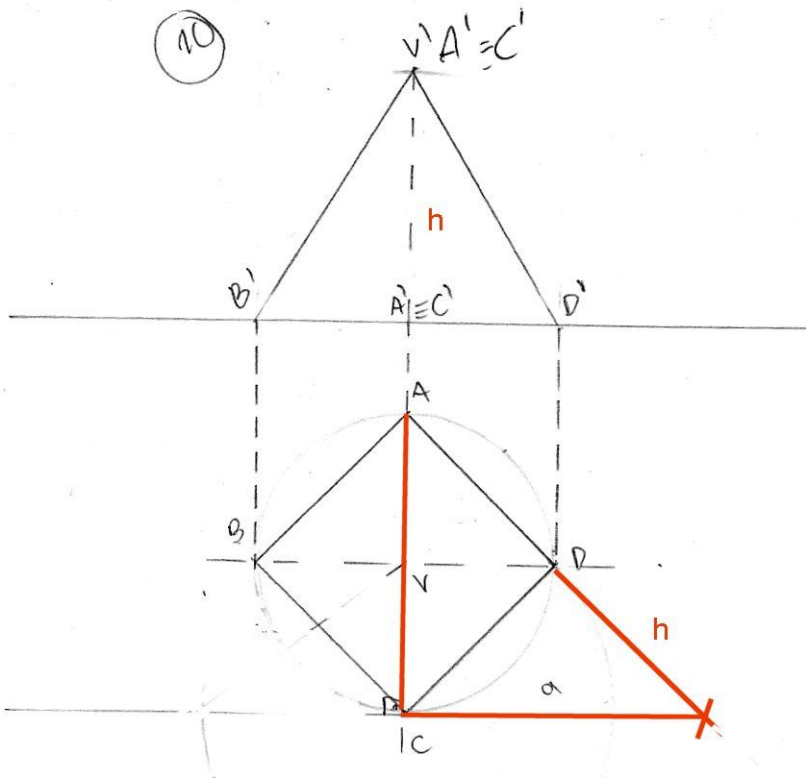

8 Dibuja el corte del plano sobre la figura

9

